

# OPTUNE LUA

## For Mesothelioma User Manual

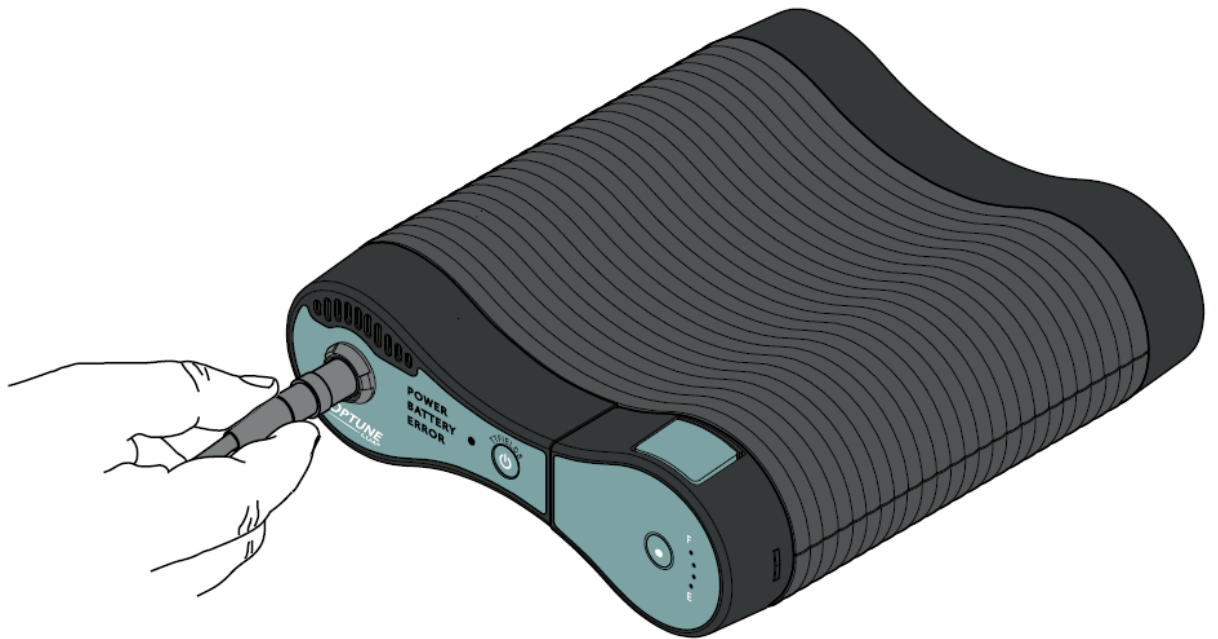

Model number: TFT9200  
Ref number : TFT9200EU

## Contents

1.	ABOUT THE OPTUNE LUA TREATMENT KIT AND THE ILE TRANSDUCER ARRAYS .....	3
1.1.	Device Description .....	3
1.2.	Intended Purpose .....	3
1.3.	Contraindications, Warnings, Precautions and Notices.....	3
2.	CLINICAL BENEFIT AND CLINICAL EVIDENCE .....	7
3.	WHAT ARE THE RISKS OF USING OPTUNE LUA TREATMENT KIT AND ILE TRANSDUCER ARRAYS? .....	8
4.	MECHANISM OF ACTION AND PERFORMANCE.....	9
5.	OVERVIEW OF THE OPTUNE LUA TREATMENT KIT AND ILE TRANSDUCER ARRAYS ...	10
6.	GLOSSARY OF SYMBOLS.....	13
7.	BEFORE YOU BEGIN .....	16
8.	DIRECTIONS FOR USE.....	17
8.1.	Removing The Transducer Array From Its Package .....	17
8.2.	Preparing Your Skin For Transducer Array Placement.....	18
8.3.	Placing The Transducer Arrays .....	18
8.4.	Connecting The ILE Transducer Arrays To The Optune Lua Device .....	19
8.5.	The Connection Cable .....	20
8.6.	Starting & Stopping The Device.....	21
8.7.	Connecting & Disconnecting The Battery .....	25
8.8.	Charging The Battery .....	27
8.9.	Using The Power Supply .....	29
8.10.	Disconnecting From The Device .....	30
8.11.	Carrying The Device .....	32
9.	ENVIRONMENTAL CONDITIONS - NORMAL OPERATION, STORAGE & TRANSPORTATION .....	33
10.	EXPECTED LIFE .....	34
11.	DISPOSAL.....	35
12.	TROUBLESHOOTING .....	36
13.	ASSISTANCE & INFORMATION.....	40
14.	GLOSSARY.....	41
15.	APPLICABLE STANDARDS .....	42
16.	MESOTHELIOMA.....	43
17.	EMITTED RADIATION AND ELECTROMAGNETIC COMPATIBILITY.....	44

## 1. ABOUT THE OPTUNE LUA TREATMENT KIT AND THE ILE TRANSDUCER ARRAYS

### 1.1. Device Description

The Optune Lua is a portable device. It produces electric fields, called tumor treating fields (“TTFIELDS”). ILE Transducer Arrays connected to the device deliver TTFIELDS to the chest. The TTFIELDS are intended to destroy lung cancer cells.

The Optune Lua treatment kit refers to the Electric Field Generator (Optune Lua, the device), connection cable, power supply, batteries, battery charger and ILE Transducer Arrays.

### 1.2. Intended Purpose

The Optune Lua treatment kit is indicated for the treatment of patients with unresectable, advanced or metastatic mesothelioma to be used concurrently with pemetrexed and platinum-based chemotherapy.

The treatment is intended for adult patients, 18 years of age or older.

The device is intended for home treatment of at least 18 hours a day on a monthly average.

### 1.3. Contraindications, Warnings, Precautions and Notices

#### CONTRAINDICATIONS

**Do not** use the Optune Lua treatment kit if you have an electrical implant.

**Do not** use the Optune Lua treatment kit if you are known to be sensitive to conductive hydrogels like the gel used on electrocardiogram (ECG) stickers or transcutaneous electrical nerve stimulation (TENS) electrodes. In this case, skin contact with the gel used with the Optune Lua treatment kit may commonly cause increased redness and itching, and rarely may even lead to severe allergic reactions such as shock and respiratory failure.

#### WARNINGS

**Warning** - Use the Optune Lua treatment kit only after receiving training from qualified personnel, such as your doctor, a nurse, or other medical personnel who have completed a training course given by the device manufacturer (Novocure GmbH Switzerland). Your training will include a detailed review of this manual and practice in the use of the treatment kit. In addition, you will be trained in what to do if there are problems with treatment. Use of Optune Lua without receiving this training can result in breaks in

treatment and may rarely cause increased skin rash, open sores on your body, allergic reactions or even an electric shock.

**Warning** - In case of skin irritation, which appears as redness under the transducer arrays (a mild rash), talk to your doctor before starting any treatment for skin irritation. Your doctor may recommend using over-the-counter topical steroids when replacing transducer arrays. This will help relieve your skin irritation. If you do not use this cream, the skin irritation can become more serious and may even lead to skin break down, infections, pain and blisters. If this happens, stop using the topical steroid cream and contact your doctor. Your doctor will supply you with an antibiotic cream to use when replacing transducer arrays. If you do not use this cream, your symptoms may continue, and your doctor may ask you to take a break from treatment until your skin heals.

**Warning** - All servicing procedures must be performed by qualified and trained personnel. If you attempt to open and service the treatment kit alone you may cause damage to the treatment kit. You could also get an electric shock by touching the inner parts of the device.

**Warning** - No modification of this equipment is allowed.

## PRECAUTIONS

**Caution** – Do not use any parts that do not come with the Optune Lua treatment kit, or that were not sent to you by the device manufacturer or given to you by your doctor. Use of other parts, manufactured by other companies or for use with other devices, can damage the device. This may lead to a break in treatment.

**Caution** – Do not use the Optune Lua treatment kit if any parts look damaged (torn wires, loose connectors, loose sockets, cracks or breaks in the plastic case). Use of damaged components can damage the device and cause a break in treatment.

**Caution** – Do not wet the device or transducer arrays. Getting the device wet may damage it, preventing you from receiving treatment for the right amount of time. Getting the transducer arrays very wet is likely to cause the transducer arrays to come loose from your skin. If this happens, the device will turn off and you will need to change the transducer arrays.

**Caution** – Before connecting or disconnecting the transducer arrays, make sure that the Optune Lua power switch is in the OFF position. Disconnecting transducer arrays with the device power switch in the ON position may cause a device alarm to go off, and could damage the device.

**Caution** - If you have an underlying serious skin condition on the chest, discuss with your doctor whether this may prevent or temporarily interfere with treatment.

**Caution** – Do not use the Optune Lua treatment kit if you are pregnant, you think you might be pregnant, or are trying to get pregnant. If you are a woman who is able to get pregnant, you should use birth control when using the device. The Optune Lua treatment kit was not tested in pregnant women. It is unknown what side effects the device may cause if you are pregnant or if it will be effective.

**Caution** -Connection cable may pose a hazard of strangulation. Avoid wearing the connection cable around your neck.

**Caution** - Do not place the power supply to make it difficult to disconnect the wall plug-in from the wall socket.

## NOTICES

**Notice**- The Optune Lua treatment kit and transducer arrays will activate metal detectors.

**Notice**- You should use the Optune Lua for at least 18 hours a day. Using the Optune Lua treatment kit for less than 18 hours a day lowers the chances that you will respond to treatment.

**Notice**- Do not stop using the Optune Lua even if you have used it less than the recommended 18 hours per day. You should stop using the device only if your doctor tells you to. Stopping treatment could lower the chances that you will respond to treatment.

**Notice** - If you plan to be away from home for more than 1 hour, carry an extra battery and/or the power supply with you in case the battery you are using runs out. If you do not take an extra battery and/or the power supply, you may have a break in your treatment.

**Notice** - Make sure you have at least 12 extra transducer arrays at all times. This will last you until the next transducer array shipment arrives. Remember to order more transducer arrays when there are at least 12 extra transducer arrays left. If you do not order transducer arrays in time, you may have a break in your treatment.

**Notice** - Batteries may weaken over time and need to be replaced. You will know this has happened when the amount of time the device can run on a fully charged battery begins to shorten. For example, if the low battery indicator light flashes within only 1 hour from the start of treatment, replace the battery. If you do not have replacement batteries when your batteries run out, you may have a break in your treatment.

**Notice** - You should carry the Troubleshooting Guide at all times. This guide is necessary to ensure the Optune Lua treatment kit works properly. If you do not operate the treatment kit correctly, you may have a break in your treatment.

**Notice** - Do not block the device vents located on the front and back of the device. Blocking the vents may cause the device to overheat and turn off, leading to a break in

treatment. If this happens, unblock the vents, wait 5 minutes and restart the device. In case the vents are blocked with pet hair or dust, return the device for service.

**Notice** - Do not block the battery charger vents located on the sides of the battery charger. Blocking the vents may cause the charger to overheat. This could prevent your batteries from charging. If the vents become blocked with pet hair or dust, return the charger for service.

**Notice** - The transducer arrays are for single use and should not be taken off your body and put back on again. If you put a used transducer array back on your chest again, it may not stick well to your skin and the device could turn off.

**Notice** - Keep the Optune Lua treatment kit out of the reach of children and pets.

**Notice** - The device has a cord that may cause tripping when connected to an electric socket.

## **2. CLINICAL BENEFIT AND CLINICAL EVIDENCE**

### **Clinical Benefit**

Patients using Optune Lua together with cancer drugs lived longer compared to patients who used cancer drugs alone. In the clinical study, half of the patients lived for more than 18.2 months compared to 12.1 months for cancer drugs alone. Also, double the number of patients using Optune Lua together with cancer drugs were alive after two years (40%) compared to cancer drugs alone (20%).

### **Clinical Evidence**

A clinical study, referred to as the STELLAR Study, was conducted to evaluate the use of Optune Lua concurrent with cancer drugs to treat unresectable (unable to be removed via surgery) mesothelioma. The study included 80 subjects.

Subjects who used Optune Lua with cancer drugs lived a longer time compared to subjects who took cancer drugs alone in the past.

Half of the patients who used Optune Lua with cancer drugs lived for more than 18.2 months after their treatment started and half of the patients did not experience growth of their mesothelioma for more than 7.6 months after their treatment started. 95% of patients had a partial response or stable disease

The occurrence of systemic medical problems when using Optune Lua with cancer drugs was the same as in subjects who used cancer drugs alone in the past.

Local skin problems under the transducer arrays were seen in 57 of 80 patients in the study (red rash, small sores or blisters). This was expected. None of these cases of skin problems caused damage to the skin that could not be fixed. The irritation went away after being treated with steroid cream and moving the transducer arrays. Only 4 subjects had severe skin problems.

These problems led to stopping treatment in 3 subjects. In all cases, the rash went away after stopping treatment.

### 3. WHAT ARE THE RISKS OF USING OPTUNE LUA TREATMENT KIT AND ILE TRANSDUCER ARRAYS?

Skin irritation is often seen under the transducer arrays when using the Optune Lua treatment kit. This will look like a red rash, small sores or blisters on your chest. In general, this will not cause skin damage that cannot be fixed.

The irritation can be treated with steroid cream or by moving the transducer arrays. If you do not use steroid cream, the skin irritation could become more serious. This may lead to open sores, infections, pain and blisters. If this happens, stop using the steroid cream and contact your doctor.

In a clinical study of the Optune Lua treatment kit together with cancer drugs used to treat your kind of lung cancer, the device led to skin irritation in about two thirds of the patients (66%). Most of these cases were not severe and were treated with topical creams. Only a handful of patients (5%) had irritation rash under the device transducer arrays and other skin problems.

The table below shows how often severe medical problems occurred in patients using the Optune Lua treatment kit together with cancer drugs, in this clinical study. Only skin irritation was caused by the Optune Lua treatment kit. The rest of the medical problems were due to the cancer itself or the cancer drugs used with the device.

Medical Problem	Optune Lua treatment kit together with Cancer Drugs
Lower white and red blood cell counts	18 out of 80 subjects (23%)
General disorders	6 out of 80 subjects (8%)
Rash under device transducer arrays and other skin problems	4 out of 80 subjects (5%)
Breathing disorders	4 out of 80 subjects (5%)
Vomiting and Ulcer	3 out of 80 subjects (4%)
Heart disorders	3 out of 80 subjects (4%)
Infections	2 out of 80 subjects (3%)
Muscle disorders	1 out of 80 subjects (1%)
Kidney disorders	1 out of 80 subjects (1%)
Liver disorders	1 out of 80 subjects (1%)

Below is a list of the potential problems associated with the correct or incorrect use of the Optune Lua treatment kit.

- Treatment related skin toxicity
- Allergic reaction to the plaster or to the gel
- ILE Transducer Array overheating leading to pain and/or local skin burns
- Infection at the sites of ILE Transducer Array contact with the skin
- Local warmth and tingling sensation beneath the ILE Transducer Array
- Medical device site reaction
- Muscle twitching

- Skin breakdown / skin ulcer

#### **4. MECHANISM OF ACTION AND PERFORMANCE**

Your doctor has prescribed the Optune Lua treatment kit for use at home because you are a good candidate for treatment with the device.

A doctor may prescribe the Optune Lua treatment kit to treat a patient with mesothelioma which cannot be cured with surgery or radiation.

The Optune Lua treatment kit is used concurrently with pemetrexed and cisplatin or carboplatin (types of cancer drugs).

The Optune Lua treatment kit is a portable device. It produces electric fields, called tumor treating fields (“TTFIELDS”). The ILE Transducer Arrays connected to the device deliver TTFIELDS to your chest. The TTFIELDS are intended to destroy lung cancer cells.

The device and battery are carried in a shoulder bag. You should use them as much as you can.

In this manual, the term “Optune Lua treatment kit” refers to the TTFIELDS Generator (also called “the device”), connection cable, power supply, batteries, battery charger and ILE Transducer Arrays.

## 5. OVERVIEW OF THE OPTUNE LUA TREATMENT KIT AND ILE TRANSDUCER ARRAYS

You may be able to use the Optune Lua treatment kit on your own, or you may need help from a doctor, family member, or other caregiver.

Use the Optune Lua treatment kit as many hours per day as possible. You can take short breaks for personal needs.

When starting treatment, your doctor or a representative from Novocure will teach you how to use the device, replace transducer arrays, recharge and replace batteries, and plug in the device. Your Novocure representative will also teach you what to do if an alarm beeps and will give you a telephone number to call for technical support. After this short training, with the help of a family member or care provider if needed, you will be able to properly use the Optune Lua treatment kit.

You will also be able to change the batteries, charge the batteries and replace the transducer arrays as needed.

The device can be carried when you are using a battery. You can continue your normal daily life while carrying the device in a shoulder bag. The Optune Lua treatment kit includes four rechargeable batteries. Each battery will last for up to two hours. For sleeping, or other times when you plan to stay in the same place for a while, plug the device into a standard wall outlet.

The Optune Lua treatment kit does not need regular maintenance. The device also does not have any settings for you to change. The only things you need to do are check that the device has a power supply (a charged battery or is plugged into the wall) and turn it ON and OFF. If the device is not working, an alarm will beep. A Troubleshooting Guide is provided in this manual (Section 12).

You can also call the 24-hour technical support telephone number (Section 13).

Change the transducer arrays at least twice a week. Keep treatment breaks to a minimum. You can interrupt treatment for personal needs such as bathing, exercise, or any time you need a planned treatment break. You will need to stop treatment (turning the device OFF) to replace the transducer arrays. To take a shower, unplug the transducer arrays from the device (leave the transducer arrays on your chest) and wrap your chest with a waterproof wrapping so it does not get wet. You can take a full shower and wet your entire body when you are not wearing the transducer arrays (for example, when you have taken them off but before replacing them with a new pair).

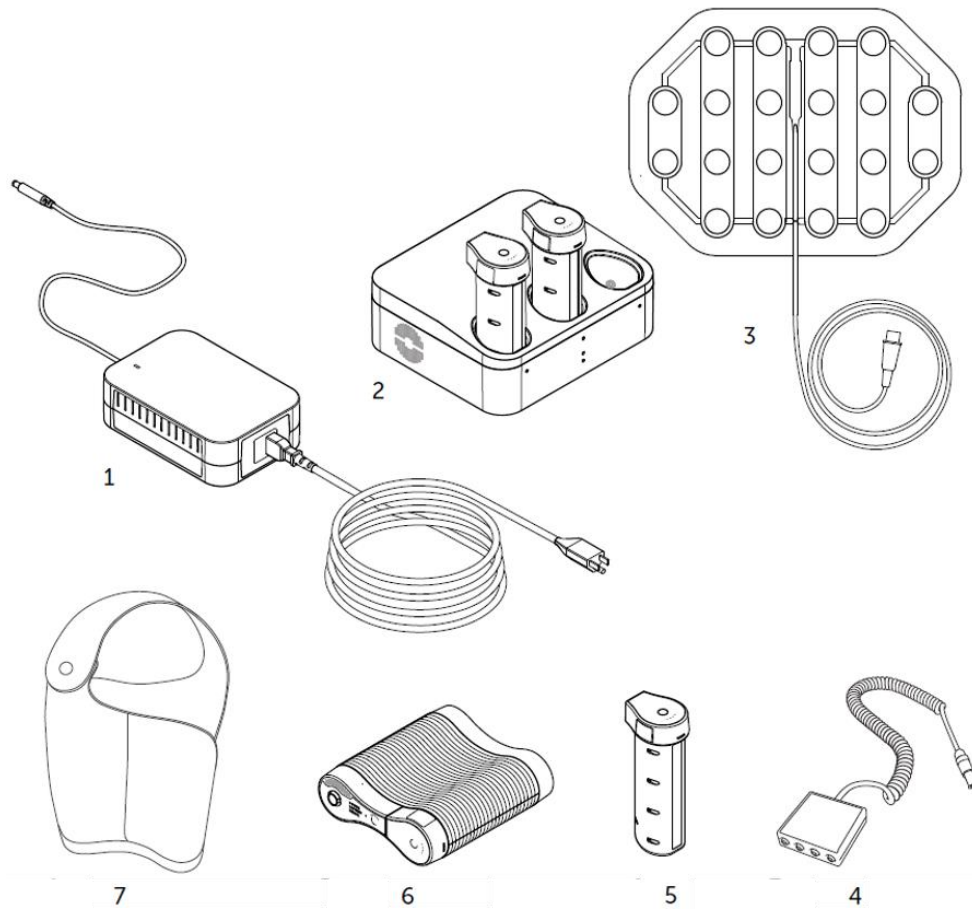

- |  |  |
|--|--|
| 1. Optune Lua Power Supply                           | (SPS9200)  |
| 2. Charger for Optune Lua Battery                    | (ICH9100)  |
| 3. ILE Transducer Array                              | (Small: ILE1010, ILE1010W)<br>(Large: ILE1030, ILE1030W) |
| 4. Optune Lua Connection Cable                       | (CAD9100)  |
| 5. Optune Lua Battery                                | (IBH9200)  |
| 6. Optune Lua™ electric field generator – the device | (TFT9200)  |
| 7. Carrying Bag                                      |  |

No modification of this equipment is allowed.





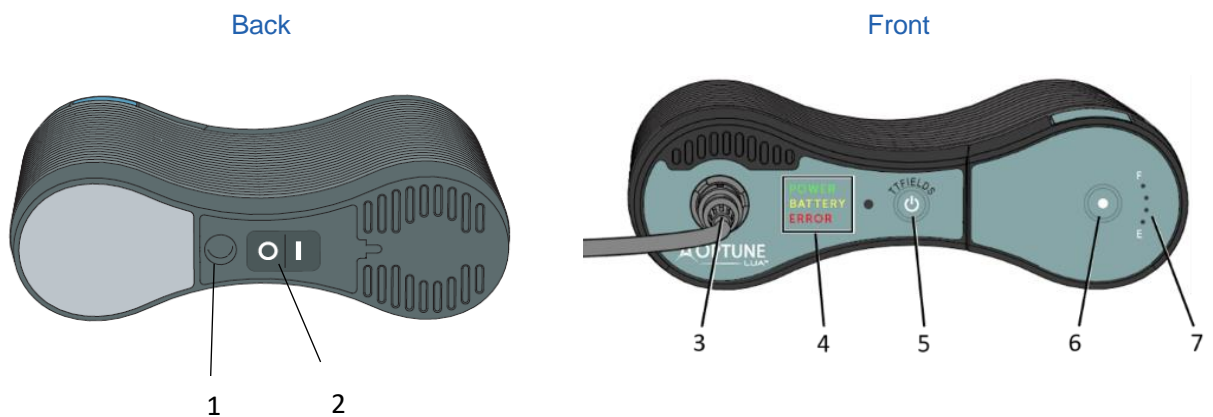







## Device



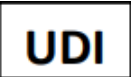





- The Optune Lua is an automatic device.
- The TTFIELD treatment should be kept on as continuously as possible (at a minimum 18 hours a day, 7 days a week). Breaks from treatment should be kept as short as possible.
- You will need to learn how to place it in a carrying bag, connect a battery and operate the device
- The following controls will allow you to do this:











1. Power Supply Port
2. Optune Lua Power Switch
3. Connection Cable (CAD) Socket
4. POWER / BATTERY / ERROR Indicators
5. TTFIELDS ON / OFF Button
6. Battery Test Button
7. Battery Gauge

## 6. GLOSSARY OF SYMBOLS

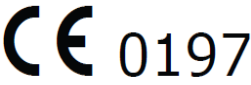
	Follow instructions for use
	Medical device
	Manufacturer Information: Novocure GmbH, Neuhofstrasse 21, 6340 Baar, Switzerland
	Model number
	Part number
	Serial number
	Lot number
	Unique Device Identifier Indicates a device carries Unique Device Identifying information.
	Manufacture date
 YYYY-MM	Use-by date/Expiry date
	Caution Consult the instructions for use for important information such as warnings and precautions
	Waste Electrical and Electronic Equipment recycling “WEEE disposal” Contact technical support to arrange for proper disposal of arrays that are used up or no longer in use.
	Batteries are Lithium Ion. Contact technical support to arrange for proper disposal of batteries that are used up or no longer in use

	<p>Do not re-use. The ILE Transducer Arrays are for single use and should not be re-used.</p>
	<p>Indicates that the packaged products are sterile, the products have been sterilized by irradiation and the packaging is a single sterile barrier system</p>
	<p>Sterile/sterilization method. The ILE Transducer Arrays are sterilized by Gamma irradiation</p>
	<p>Do not re-sterilize</p>
	<p>Do not use if package is damaged. Do not use the ILE Transducer Arrays if their packaging is breached.</p>
	<p>Protect from heat and radioactive sources The Optune Lua device and treatment kit parts should be kept away from extreme heat and sources of radiation</p>
<p><b>IPxx</b></p>	<p>IP code: A coding system to indicate the degrees of protection provided by an enclosure against access to hazardous parts or water.</p> <p>IP21: The power supply protects persons against access to hazardous parts with fingers. Protects the equipment inside the enclosure against ingress of solid foreign objects of 12.5 mm in diameter or greater and against ingress of vertical falling water drops.</p> <p>IP22: The device protects persons against access to hazardous parts with fingers. Protects the equipment inside the enclosure against ingress of solid foreign objects of 12.5 mm in diameter or greater and against ingress of vertical falling water drops when enclosure is tilted up to 15°.IP21: Optune Power supply protects persons against access to hazardous parts with fingers. Protects the equipment inside the enclosure against ingress of solid foreign objects of 12.5 mm in diameter or greater and against</p>
	<p>Keep dry. Do not enter rooms with high humidity or danger of direct exposure to water while wearing the device. Do not use the device if not within its carrying bag. Do not expose the device to direct rain.</p>
	<p>For indoor use only The charger and power supply are for indoor use only</p>
	<p>Class II equipment per IEC 60601-1</p>

	<p>BF type applied part Symbolizes the part which comes in contact with the patient</p>
	<p>Storage Temperature range Do not expose to temperatures below -5°C or above 40°C</p>
	<p>Storage humidity range Do not expose to humidity below 15% or above 93%</p>
	<p>Fragile, handle with care</p>
	<p>P1 P2 N1 N2 black and white coding on the connection box</p>
	<p>CE Mark with Notified Body number</p>
	<p>European authorized representative MDSS GmbH Schiffgraben 41 30175 Hannover, Germany</p>
	<p>Importer details: Novocure Netherlands B.V., Prins Hendriklaan 26, 1075 BD, Amsterdam, The Netherlands</p>
	<p>Power ON / OFF switch for the device and battery charger: When the switch is in the I position the device is ON and will light up green When the switch is in the O position the device is OFF</p>

## 7. BEFORE YOU BEGIN

- An ILE Transducer Array is an adhesive patch which delivers Tumor Treating Fields to the chest.
- You will need four (4) ILE Transducer Arrays (Sterile) every 3-4 days in order to maintain treatment with the Optune Lua Treatment kit.
- You will need to make sure you have the right sized transducer arrays for your torso size.
- Make sure you have an ample supply of ILE Transducer Arrays to keep you going until your next visit to your doctor.
- Before using an ILE Transducer Array make sure the package is sealed by gently rubbing the package between thumb and pointer finger on all four sides. The package should be closed on all sides. There should be no openings in the package seal. If the package is not sealed, the transducer array may be damaged. A damaged transducer array will not work properly and may cause the device to turn off. **Do not** use an ILE Transducer Array which has been opened previously. The ILE Transducer Arrays are for single use and should not be re-used.
- The ILE Transducer Arrays are provided sterile for single use.
- Maintenance and cleaning – The ILE Transducer Arrays are supplied sterile for single use, they do not require maintenance, cleaning or disinfection.
- The ILE Transducer Arrays are to be used with the Optune Lua treatment kit only.
- Your doctor will show you where to place each array on your chest

## 8. DIRECTIONS FOR USE

### 8.1. Removing The Transducer Array From Its Package

The ILE Transducer Arrays come in two sizes – small and large. You should use two large transducer arrays on the back and front of your chest. You should use either two large or two small transducer arrays on both your flanks (on your sides beneath your armpits), depending on your chest size.

Open the see-through envelope of each of the four (4) ILE Transducer Arrays by gently pulling apart the opposing edges of the envelope. Hold the transducer array as shown in the illustration.

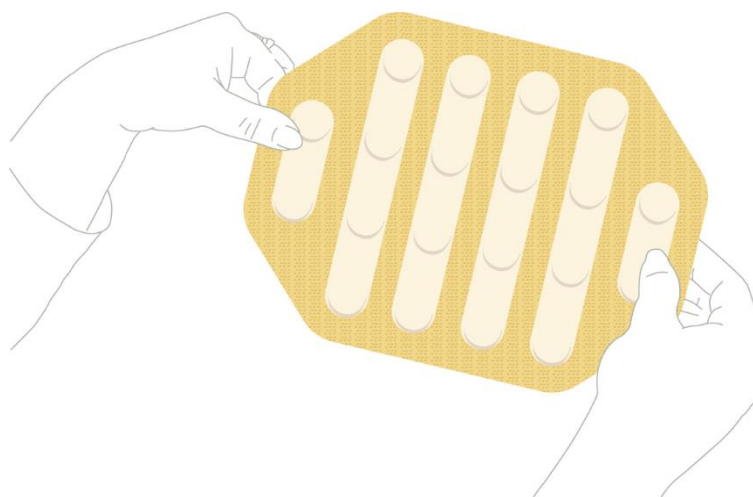
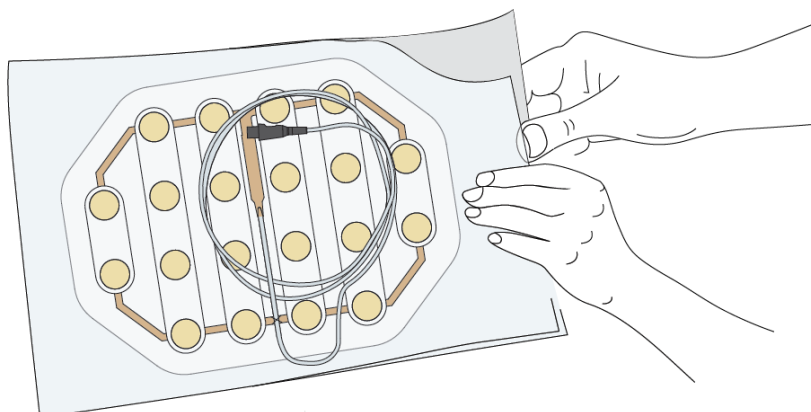

## **8.2. Preparing Your Skin For Transducer Array Placement**

- Wash your skin on the chest and flanks using a gentle soap.
- Remove any remnant adhesive from your skin from prior transducer arrays by wiping with baby oil.
- If you have significant chest hair, shave your entire torso using an electric shaver. Make sure no stubble is left.
- Wipe your skin with 70% Alcohol (medical grade – any manufacturer).
- If the skin is red, apply the steroid cream prescribed to you by your doctor.
- If you have any sores on your skin treat them as instructed by your treating doctor.
- 
- Wait at least 15 minutes and gently wipe your skin again with 70% Alcohol to facilitate adhesion of the transducer arrays to your skin.

## **8.3. Placing The Transducer Arrays**

- Once every 3-4 days (about twice a week) perform the following steps to replace your transducer arrays:
- Remove the transducer arrays already on your chest and flanks by peeling the medical tape away from your skin.
- Note the black and white color of the Transducer Array connectors - each pair of the same color will be positioned opposite to each other on your body.
- Remove the transducer array liner from the first transducer array.

- Place the transducer array on your chest in the same location as before, but shifting the transducer array 2 cm to avoid areas of redness
- Place the other three transducer arrays in the same fashion.
- You will need to ask for assistance from a friend or family member to place the back transducer array.
- Press the entire rim of the transducer array tape to your skin.

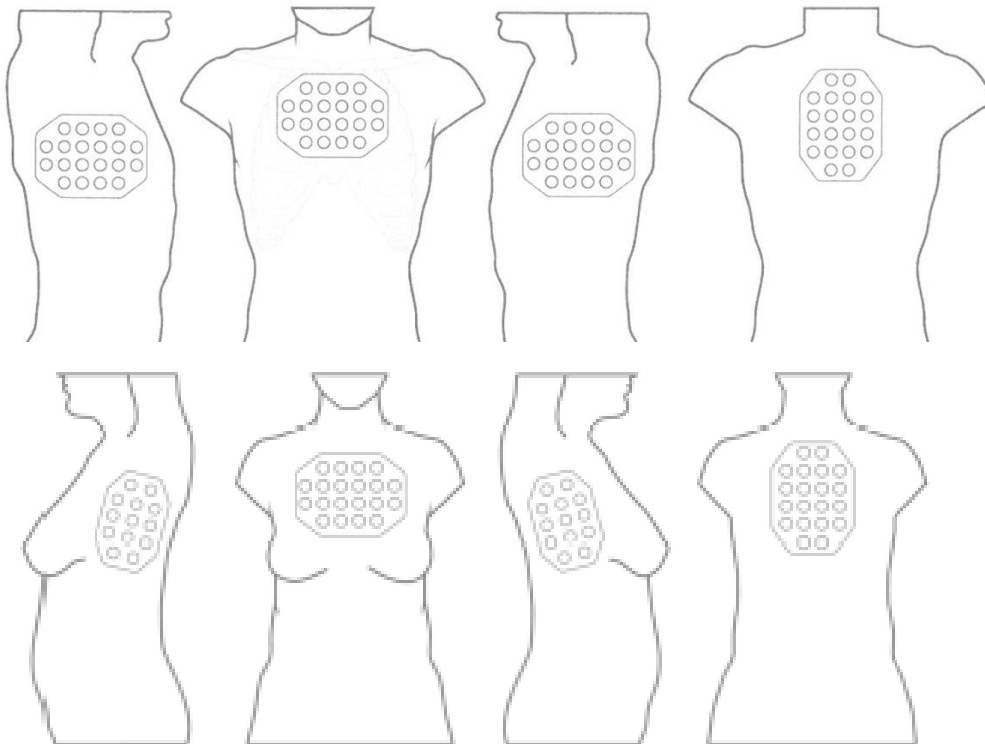

#### **8.4. Connecting The ILE Transducer Arrays To The Optune Lua Device**

1. Connect the four black and white Transducer Array connectors to the corresponding black and white coded sockets on the Optune Lua connection cable box.
2. Press firmly to verify the connectors are inserted all the way.
3. Collect the transducer array wires together and bind with a small piece of tape where convenient.

4. You may clip the connection cable clip to your belt

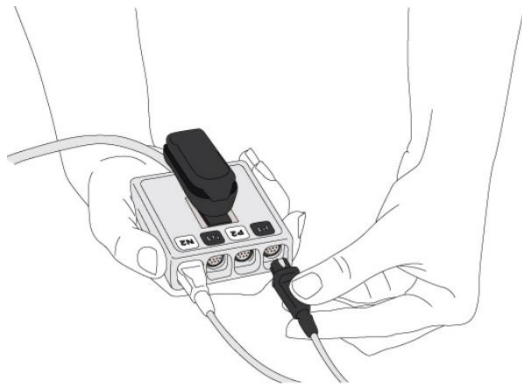

## 8.5. The Connection Cable

- The connection cable is the coiled, stretchy cord that runs from the connection box to the device. The four transducer array connectors (two black and two white) are plugged into the connection box. The black and white coding matches with the transducer array position on the body.

Follow the instructions to connect to the device:

1. Verify that the arrow on the connection cable is facing up and is aligned with the arrow on the connection cable socket of the device and plug in the connection cable.
2. Push in the connection cable until you hear a snap. It indicates that the connection cable is in its place.



## 8.6. Starting & Stopping The Device

### TO START TREATMENT:

The Transducer Arrays should be attached to your body.

1. Plug the transducer arrays into the connection cable box (see Sections **Error! Reference source not found.** and **Error! Reference source not found.**).
2. Plug the connection cable into the device, aligning connector arrow with socket arrow (see Section 8.5).
3. Connect a power source - either a charged battery (Section **Error! Reference source not found.**) or a power supply (Section 8.9) to the device.
4. Turn ON the device by using the power switch.



5. Wait about 10 seconds for the self-check to be completed, until the green “POWER” indicator illuminates.

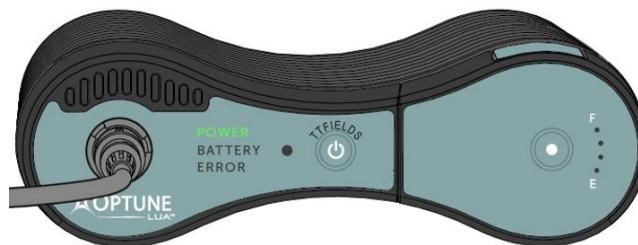

**NOTE:** If a charged battery is installed (and no power supply is connected), the green "BATTERY" indicator illuminates. If the device is connected to the power supply, it will be operated from the power supply and the "BATTERY" indicator will turn off.



6. Activate TTFIELDS by pressing the TTFIELDS ON/OFF button.

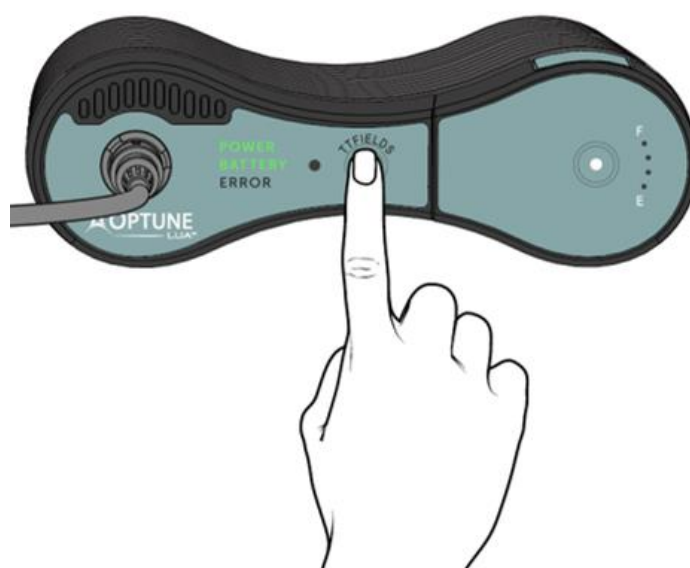

The "TTFIELDS" indicator, above the TTFIELDS ON/OFF button, should illuminate in blue and stay on while the treatment is ON.

**NOTE:**

If the blue indicator doesn't illuminate, then the treatment is OFF and you should check the setup and restart the procedure. If, after this, the indicator lights do not light up, refer to the Troubleshooting Guide (Section 12). If you still have problems, contact Novocure technical support (Section 13).

The green, blue and yellow indicators automatically dim in a dark room. The red "ERROR" indicator illumination level is permanent.

If the TTFIELDS button isn't pressed within about 10 minutes after the device is turned ON, a notification signal alarm sounds along with a flashing blue "TTFIELDS" indicator, indicating that the therapy is OFF. This is a reminder to start the therapy. The TTFIELDS button should be pressed once to silence the alarm and again to start the therapy. The blue "TTFIELDS" indicator will then illuminate.

**TO STOP TREATMENT:**

Stopping treatment may be performed in each of the following situations:

- A. When the device is running properly, and you would need to take a break:
  1. Stop treatment by pressing TFields button. TFields therapy stops, indicated by the blue “TFIELDS” indicator turn OFF.

NOTE: Device power is still ON.

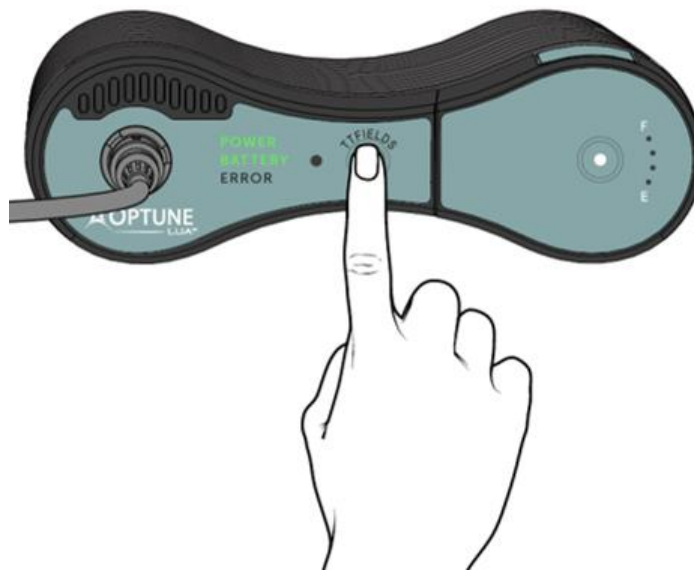

2. Turn OFF the device by using the power switch.



B. If an error occurs:

If an error occurs, the device stops the treatment and sounds a loud beeping alarm. The red “ERROR” indicator illuminates (as shown below).

1. Press TTFIELDS button to stop the alarm. The red “ERROR” indicator will turn OFF. If the alarm sound persists, proceed to the next step to silence the alarm.
2. Turn OFF the device by using the power switch.



C. If the Low BATTERY Indicator lights up:

When your battery runs out (after about one hour), the TTFIELDS output will shut down (device stops the treatment) and an alarm will sound.

NOTE: The alarm sound is identical to alarm that the device sounds when an error occurs. However, in this case, both the yellow “BATTERY” and red “ERROR” indicators light up.

1. Press the TTFIELDS button to stop the alarm. The red “ERROR” indicator turns OFF.
2. Turn OFF the device by using the power switch.
3. Replace the battery (see Section 19).



## 8.7. Connecting & Disconnecting The Battery

The Optune Lua treatment kit is provided with four rechargeable batteries. The Optune Lua device operation requires one battery at a time. The other three batteries should stay in the battery charger.

If you plan to be away from home for more than one hour, carry extra batteries.

1. Slide the battery into the device.
2. Gently push the battery down until a click is heard, indicating it is fully latched.

NOTE: Take care not to drop the battery in place or force it into the battery slot.

3. Replace the battery each time it runs out (when the green "BATTERY" indicator turns yellow)



Gently press down to lock the battery in place. To remove the battery from the slot, press both blue buttons on the sides of the battery and lift up.

Recharge the batteries in the charger (Section 8.8) for two to four hours. The batteries will keep most of their charge after being removed from the charger for several days but eventually will lose their charge. It will not hurt the batteries to keep them in the charger after they are fully charged so you can leave them there if they are not needed.

You can charge and use the batteries many times for about six to nine months. Over time, the length of time that the batteries can run the device (before the yellow low BATTERY indicator illuminates and the alarm beeps) will get shorter. If the time from treatment start with a full battery to low battery alarm, audible alarm sounds and the red "ERROR" indicator illuminates falls below 50 minutes contact technical support (Section 13) to get replacement batteries.

The battery light will turn from green to yellow when the battery charge falls below a threshold. This is an indication that the battery should be changed soon. The treatment will continue to run while the yellow low BATTERY indicator is illuminated until the audible alarm sounds and the red "ERROR" indicator illuminates. Once this happens the treatment will stop and the device must be turned off and the battery replaced.

When the “BATTERY” indicator turns yellow, there are two ways to continue your treatment:

A. Option One:

If you are near the direct wall power supply, connect the power supply to the wall outlet to provide continuous therapy. This can be used before the battery is completely depleted, and before the device has alarmed. Follow the instructions:

1. Plug in the wall power supply to back of the Optune Lua device (Section **Error! Reference source not found.**). Treatment continues while Device indicator indicates that it is no longer operated by battery power.
2. Press the two blue buttons on both battery sides and remove the battery by lifting it out of the device.
3. Charge the removed battery (Section 8.8).
4. Continue the treatment using the wall power supply.

B. Option Two:

If you are not near a wall power supply, follow the instructions to replace the battery:

NOTE: If the battery is totally depleted, start from step 2

1. Press the TTFields button to stop the treatment.
2. Turn OFF the device by using the power switch (on the back of the device).
3. Press the two blue buttons on both battery sides and remove the battery by lifting it out of the device.
4. Select another fully charged battery.
5. Slide the fully charged battery into the device.
6. Gently push the battery down until a click is heard, indicating it is fully latched.
7. See Section 8.8 to check the battery gauge.
8. Turn ON the device by using the power switch and wait about 10 seconds until the device completes with the self-check.
9. Start treatment by pressing the TTFields button (Section **Error! Reference source not found.**).
10. Insert the used battery into the battery charger for recharging (Section 8.8).



## 8.8. Charging The Battery

### CHECKING THE BATTERY GAUGE

While you are using Optune Lua, you may want to check how much energy is left in your battery. Checking the battery will not interfere with, or stop, your treatment.

To check the battery capacity, press once on the button on the top of the battery. The battery capacity will be indicated by the lighted gauge to the right of the button. The gauge reads from Full (F) to Empty (E) like a gas gauge in a car.

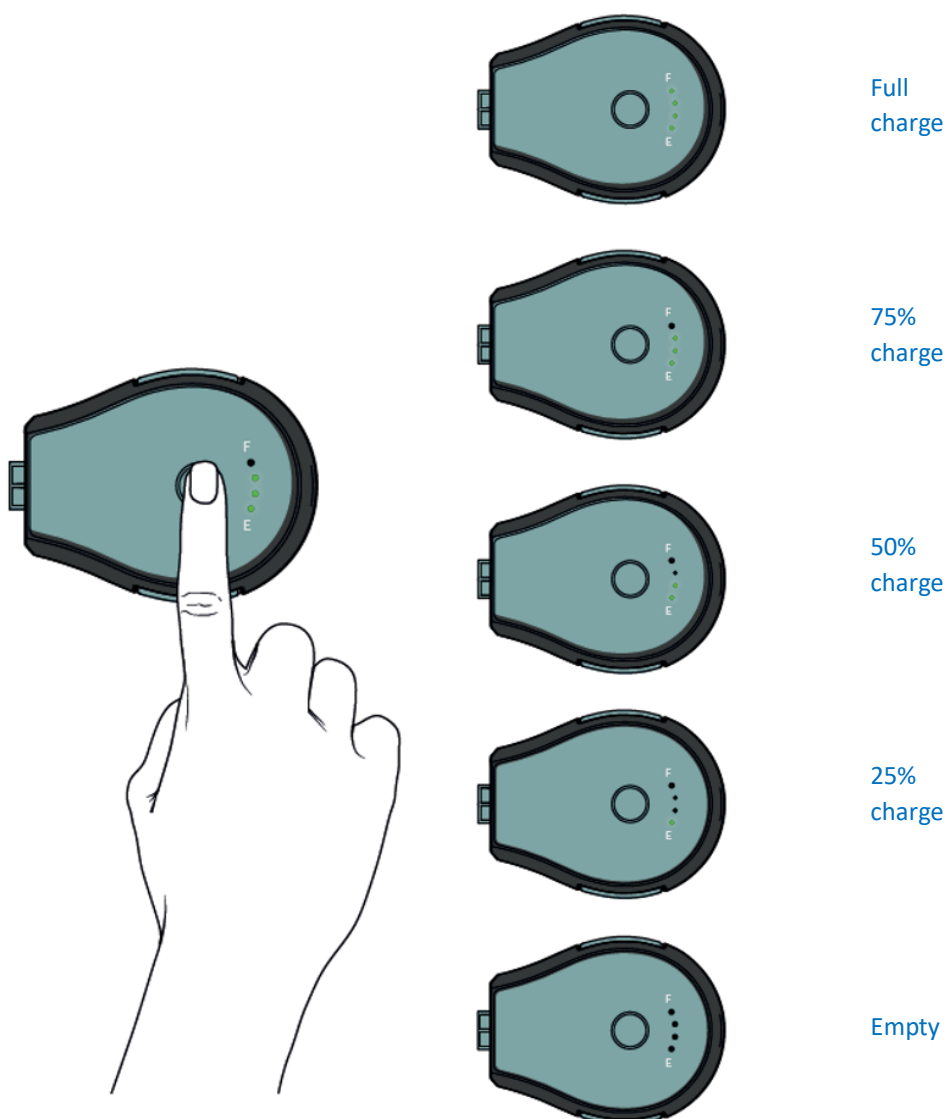

The battery charger recharges used batteries. The battery charger uses power from a standard wall outlet. Each battery sits in a slot that connects it directly to the charger.

Before charging the batteries, plug the charger power cord into a standard wall outlet and turn ON the power switch at the charger rear side. The front lights of the charger will come on during a self-check then the small light in the center of the front panel will light up green indicating power is applied.

#### TO RECHARGE A USED BATTERY:

1. Place the used battery in one of the three openings in the top of the charger. Slide the battery in until it is fully in place.
2. The light directly in front of the opening where the battery is plugged in will illuminate flashing green. This indicates the battery is charging. The green light will flash faster once the battery has been charged to 95% of its capacity. You can also check the battery gauge while charging to get information regarding the amount of charge in the battery.
3. When the battery is fully charged (about 2 to 4 hours), the charge light will turn from flashing green to solid green. The solid green light will disappear upon removal of the battery or the disconnection of the charger from the standard wall outlet.

If a light on the front panel turns red, this indicates that there is a fault with the battery or charger and you should contact technical support for assistance. Do not use a battery if it creates a red light on the charger.

Keep the batteries in the charger even after they are fully charged. This will not harm the batteries.

1. Power Switch
2. Power Cord

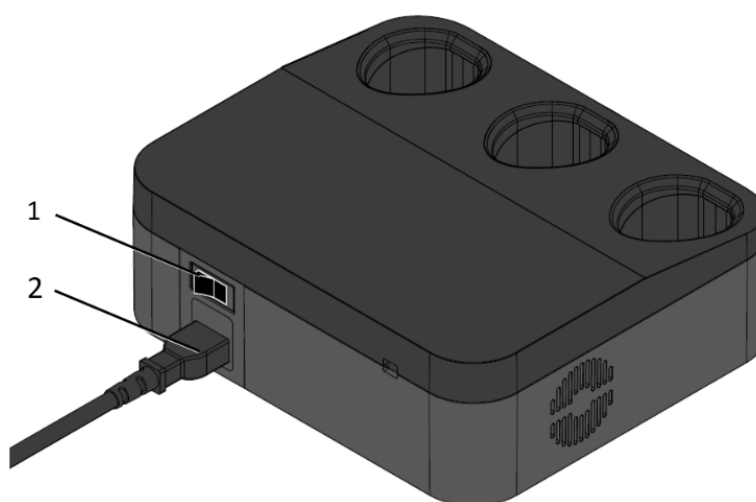

Battery Charger Rear View Showing the Power Switch and Where the Power Cord Connects

1. **Battery Charging Slot**
2. **Charger Power Indicator**
3. **Battery Charge Indicator**

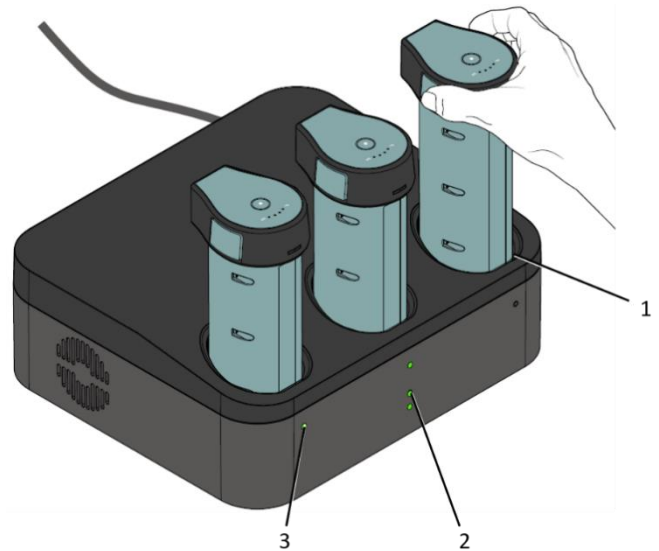

Front view of the battery charger showing how the batteries are inserted into the charger

NOTE: The charger is not intended for use in the presence of flammable mixtures.

## 8.9. Using The Power Supply

When you plan to stay in one place for a while, like when you are sleeping, you may use the plug-in power supply instead of the batteries. Unlike the batteries, there is no limit to how long the device can work when you use the plug-in power supply. The plug-in power supply will work with either US (120 VAC) or European (230 VAC) outlets.

NOTE: It is normal for the power supply to become warm when in use. If the power supply becomes too hot to touch, unplug it and contact technical support (Section 12).

When the device has a battery in, and is also connected to the wall power supply, it will utilize the wall power supply as the preferred power source. When the wall power cord is plugged in while the device is operated from the battery, the device will automatically switch from battery power to wall supply power.

### CONNECTING THE PLUG-IN POWER SUPPLY

1. Plug in the power supply cord into a standard wall outlet.

NOTE:

You do not need to remove the battery from the device to use the wall power supply. Please note that a battery in the device will not charge while the device is plugged into the wall power supply.

If the TTFields are activated, you do not need to turn them OFF.

2. Plug the power supply connector into the power supply port, located on the back side of the device (next to the power switch).

3. If the TTFields are already activated, the device will automatically switch to wall power supply without interruption of the treatment.
4. If the device is OFF, turn ON the power switch and wait about 10 seconds until the device completes with the self-check. Then, Push the TTFields button to start the treatment (as described in Section **Error! Reference source not found.**).

#### TO DISCONNECT THE PLUG-IN POWER SUPPLY AND GO BACK TO BATTERY POWER

Ensure that a charged battery is properly inserted in the device before removing the wall power supply. If the TTFields are activated, you need to turn them OFF before removing the wall power supply. The device will shut down and restart using battery power once the power supply is removed. In that case you will be required to push the TTFields button to start the treatment (as described in Section 8.6), after the self-check is completed.

1. Remove the power supply connector from the back side of the device. After about eight seconds, the “BATTERY” indicator on the front panel illuminates.
2. Store the plug-in power supply for future use.

### 8.10. Disconnecting From The Device

There are two ways to unplug the device in order to take a break from treatment:

- To unplug the connection cable from the device.
- To unplug the four transducer arrays from the connection cable box.

#### TO UNPLUG THE CONNECTION CABLE FROM THE DEVICE

1. Stop treatment by pressing the TTFields button.
2. Turn OFF the device by using the power switch.
3. Hold the connector latch-sleeve and pull out the connection cable from the socket.

CAUTION! Do not pull on the cord!

You may now move around without the device, but you will still be connected to the connection cable and box.

To start treatment again after your break:

1. Plug the connection cable into the port with the arrows pointing up.
2. Turn ON the device by using the power switch. Wait about 10 seconds until the device completes with the self-check.
3. Activate TTFields by pressing the TTFields button.

## TO UNPLUG THE TRANSDUCER ARRAYS FROM THE CONNECTION CABLE BOX

To take a break from treatment and completely disconnect from the device, unplug the transducer arrays from the connection cable box. The four transducer arrays are plugged into the connection cable box (as described in Section 8.4). The connection cable remains plugged into the device socket.

1. Stop treatment by pressing the TFields button.
2. Turn OFF the Optune Lua device by using the power switch.
3. Unplug the four transducer arrays from the connection box by pulling their connectors.

NOTE: You may have to wiggle the transducer array connectors gently to remove them. Do not pull on the cord.



To restart treatment:

1. Plug the four transducer arrays into its matching color (black or white) in the connection cable box.
2. Turn ON the device by using the power switch and wait about 10 seconds until the device completes with the self-check.
3. Activate TFields by pressing the TFields button.

## 8.11. Carrying The Device

Both the electric field generator (the device) and the battery fit in a carrying bag. The bag can be carried in one of three ways: by the handle on top or over the shoulder/ cross-body with a carrying strap attached, or as a backpack as shown below.

NOTE: Do not place the device in a different bag. Optune Lua has a fan on the inside that needs air flow. The bag that comes with the device is designed to allow for proper air flow. If you put the device in a bag without proper air flow, it could overheat and stop the treatment. If this happens, you will hear an alarm.

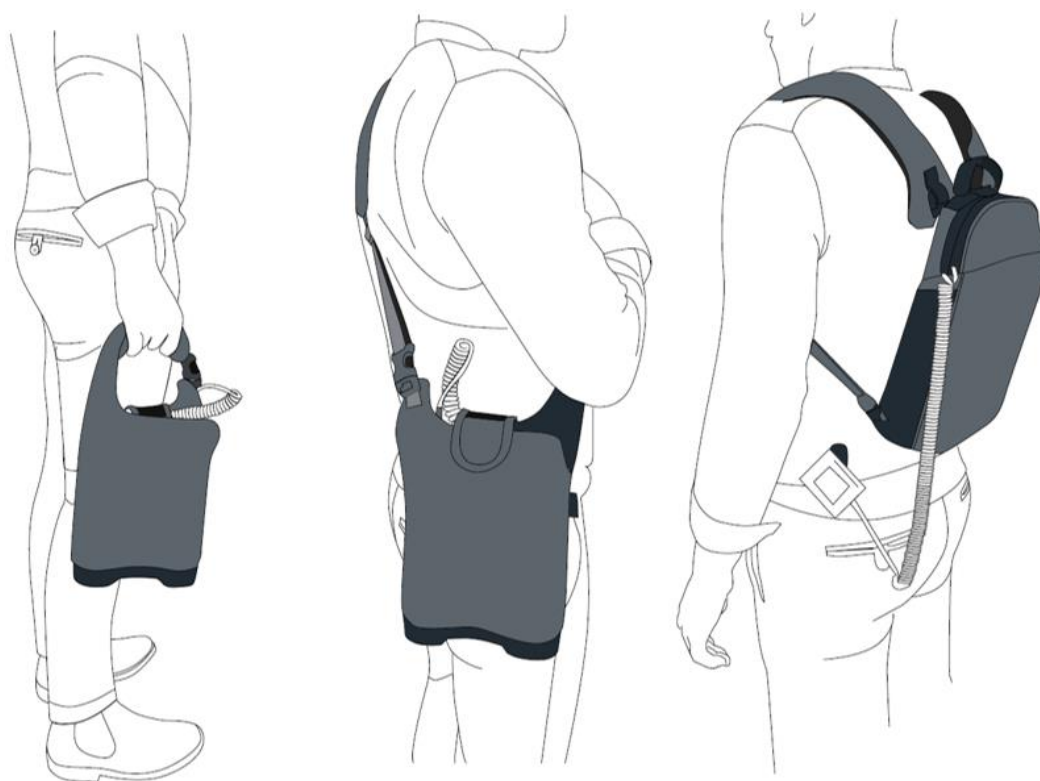

## 9. ENVIRONMENTAL CONDITIONS - NORMAL OPERATION, STORAGE & TRANSPORTATION

### CONDITIONS FOR OPERATION

All treatment kit components shall be normally used under conditions specified below:

- Mainly for home use.
- For indoor use only (chargers, power supply)
- Not for use in shower, bath tub or sink, or in heavy rain
- Not for use in presence of flammable mixtures
- Can be dropped on floor with no safety hazard, but is no longer expected to function

Conditions of visibility: any

Cleaning: all treatment kit components can be periodically cleaned with damp cloth, to remove dust and regular soil.

Physical operation conditions for all treatment kit components:

- Temperature range: -5°C to +40°C
- Relative Humidity range: 15-93%
- Ambient pressure range: 700-1060hPa

### CONDITIONS FOR STORAGE

- Temperature range: -5°C to +40°C for the device and additional parts
- Temperature range: 5°C to +27°C for the transducer arrays

### CONDITIONS FOR TRANSPORT

Transportation of the device, additional parts and ILE Transducer Arrays and additional parts shall be possible using air/ground transportation in weather protected conditions as specified below:

- Temperature range: -5°C to +40°C
- Maximal relative humidity 15-93%
- No direct exposure to water

## **10.EXPECTED LIFE**

The expected service life for the Optune Lua device and all components of the treatment kit is 5 years.

The expected service life of the ILE Transducer Arrays is 9 months.

ILE Transducer Arrays have an expiration date. Please do not use the arrays after the expiration date.

## **11.DISPOSAL**

Please contact Novocure to arrange for proper disposal of used transducer arrays.

Do not throw them in the trash.

Novocure contacts local authorities for the determination of proper disposal method for potentially biohazardous parts.

## 12.TROUBLESHOOTING

Note, when calling your device support specialist or the technical support line, please have the serial number of the equipment accessible

Problem	Possible causes	Actions to be taken
Device POWER indicator does not light up after turning ON the device	<ol style="list-style-type: none"> <li>1. Device not connected to power source</li> <li>2. Battery depleted</li> <li>3. Battery malfunction</li> <li>4. If power supply – not properly plugged into the wall</li> <li>5. Device malfunction</li> <li>6. Power supply malfunction</li> </ol>	<ol style="list-style-type: none"> <li>1. If on battery – check battery gauge to verify it is not depleted. If it is – replace with a charged battery or to power supply</li> <li>2. Verify both the device and the power source are properly connected and re-try</li> <li>3. Evaluate the integrity of all connectors. Nothing should appear to be damaged or broken in any way</li> <li>4. If device cannot be powered on by either the battery or the wall power supply or if anything appears to be damaged do not use the device</li> <li>5. Call technical support</li> </ol>
Any cable detached from transducer array/ connection cable/ device	<ol style="list-style-type: none"> <li>1. Too much physical force to cables</li> <li>2. Device malfunction</li> </ol>	<ol style="list-style-type: none"> <li>1. Silence the notification signal by pressing the TTFields button</li> <li>2. Evaluate the connectors. If intact – reconnect and re-start therapy</li> <li>3. If anything appears damaged or cannot be properly connected do not try to use the device</li> <li>4. Call technical support</li> </ol>
Device dropped or wet	Incorrect use	<ol style="list-style-type: none"> <li>1. Press TTFields button to stop therapy</li> <li>2. Turn OFF power switch</li> <li>3. Disconnect from power</li> <li>4. Call technical support</li> </ol>

Problem	Possible causes	Actions to be taken
Device alarm on, and low BATTERY indicator is yellow	<ol style="list-style-type: none"> <li>1. Low battery</li> <li>2. Device is turned ON, but the therapy has not been activated</li> </ol>	<ol style="list-style-type: none"> <li>1. Replace battery as described above in Section 19</li> <li>2. Turn ON treatment</li> <li>3. Press the TTFIELDS button to stop the alarm</li> <li>4. Wait a few seconds then press the TTFIELDS button again</li> <li>5. If the blue lights around the TTFIELDS button light up – the therapy has now been activated</li> </ol> <p>If the notification signal recurs within a few minutes:</p> <ol style="list-style-type: none"> <li>1. Silence the notification signal and power the device down completely</li> <li>2. Disconnect all equipment and make sure that nothing appears to be damaged or broken. If something is – replace the damaged item before trying to power the device back</li> <li>3. Re-connect all equipment in proper order and power the device back up. Verify the self-check is completed and press the TTFIELDS button</li> <li>4. Check vents on device to make sure they are not blocked</li> <li>5. If lying down, get up and move your body</li> <li>6. Make sure transducer arrays are well stuck to the body, add tape if needed</li> <li>7. Restart treatment</li> <li>8. If alarm keeps going, turn OFF the device and call technical support</li> </ol>

Problem	Possible causes	Actions to be taken
<p>Device alarm is flashing, the "TTFIELDS" indicator above the TTFIELDS button will flash blue and audio sound 3 very short beeps, stops for 2.5 seconds and beeps 3 times again</p>	<p>Therapy Timeout</p>	<p>The notification alarm on the device will sound if it is powered on for about 10 minutes, but therapy is not initiated. This is a reminder to start therapy and does not indicate a malfunction.</p> <ol style="list-style-type: none"> <li>1. Silence the notification alarm by pressing the TTFIELDS button then wait a few seconds and press the TTFIELDS button again to initiate treatment. The blue indicator around the TTFIELDS button will illuminate to indicate therapy is now on</li> <li>2. If you encounter further alarms please review the following troubleshooting descriptions in this section.</li> </ol>
<p>Low BATTERY indicator remains on after battery replaced</p>	<ol style="list-style-type: none"> <li>1. Charger malfunction</li> <li>2. Battery malfunction</li> <li>3. Device malfunction</li> </ol>	<ol style="list-style-type: none"> <li>1. Replace battery with an additional charged battery</li> <li>2. If problem is not fixed – call technical support</li> </ol>
<p>When powering on the device a continuous notification alarm sounds and all lights remain on indefinitely. Device does not complete the self-check.</p>	<ol style="list-style-type: none"> <li>1. Device is too hot</li> <li>2. Device malfunction</li> <li>3. Power Source Malfunction</li> </ol>	<ol style="list-style-type: none"> <li>1. Power the device off completely using the power switch</li> <li>2. Verify the device is not hot to the touch</li> <li>3. Connect the device to a different power source and try powering on again</li> <li>4. If device cannot be powered on by either the battery or the wall power supply or if anything appears to be damaged, please contact technical support</li> </ol>
<p>Redness of the skin beneath the transducer arrays</p>	<p>Common side effect</p>	<ol style="list-style-type: none"> <li>1. Use steroid cream prescribed by your doctor when replacing transducer arrays.</li> <li>2. Place transducer arrays in a location shifted by 3/4 of an inch (2 cm) from the last location (so the adhesive gel is between the red marks).</li> </ol> <p>If the redness gets worse:</p> <ol style="list-style-type: none"> <li>1. See your treating doctor</li> </ol>
<p>Blisters beneath the transducer arrays</p>	<p>Rare side effect</p>	<p>See your treating doctor</p>

Problem	Possible causes	Actions to be taken
Itching beneath the transducer arrays	Rare side effect	1. Use steroid cream prescribed by your doctor when replacing transducer arrays. 2. Place transducer arrays in a location shifted by 3/4 of an inch (2 cm) from the last location (so the adhesive gel is between the red marks). If the itching gets worse: 1. See your treating doctor
Pain beneath the transducer arrays	Rare side effect	1. Stop treatment 2. See your treating doctor

## 13. ASSISTANCE & INFORMATION

### TECHNICAL SUPPORT:

For technical support, contact your Device Support Specialist. His/her contact information will be supplied to you separately.

For technical support email [support@novocure.com](mailto:support@novocure.com) or [patientinfoEMEA@novocure.com](mailto:patientinfoEMEA@novocure.com). Email technical support for help with operation of the treatment kit, troubleshooting alarms, or to get replacement parts or transducer arrays.

Please describe the problem and provide the following information when you contact:

NAME (First/Last)

EMAIL

TELEPHONE (optional)

COUNTRY:

QUESTION:

### CLINICAL SUPPORT:

If you feel any change in your health or any side effects from the treatment call the doctor who is treating you.

### TRAVELING WITH OPTUNE LUA

The treatment kit's batteries contain lithium ion material and are restricted from being checked as luggage for passenger aircraft travel. They can be carried in the passenger cabin. Please contact your DSS if you have questions related to travel restrictions.

Note: The Optune Lua device and transducer arrays will activate metal detectors.

### REPORTING

If you experience a serious incident that occurs while using the Optune Lua treatment kit and ILE Transducer Arrays you should report it to the manufacturer (Novocure) and the competent authority of the Member State in which you reside.

## 14.GLOSSARY

**Cancer** – abnormal cell division that spreads without control

**Carboplatin** – a type of cancer drug used to treat mesothelioma

**Chemotherapy** – medication used to destroy cancer cells

**Cisplatin** – a type of cancer drug used to treat mesothelioma

**Clinical trial** – a research study that involves people

**Contraindications** – situations when a treatment should not be used

**CT scan** – a procedure that uses radiation to create pictures of areas inside the body

**Electric Field Generator (the device)** – a portable device for delivering TTFIELDS to the lungs of patients with MPM

**Local** – in one part of the body

**t Mesothelioma)** – a type of cancer which affects the linings of the lungs

**Optune Lua® treatment kit** – the Electric Field Generator and other parts including batteries, charger, connection cable, power supply and ILE Transducer Arrays

**Pemetrexed** – a type of cancer drug used to treat mesothelioma

**Progression** – when cancer comes back after being treated

**Radiation** – a treatment involving x-rays used to kill tumor cells

**Steroids** – When used on the skin, a medication that can reduce inflammation

**Systemic** – throughout the body

**Topical** – on the surface of the skin

**Transducer Array** – adhesive bandages that hold insulated ceramic discs that deliver TTFIELDS to the chest

**TTFIELDS** – Tumor Treating Fields: Alternating electric fields, delivered using transducer arrays to the part of the body with a solid tumor. The fields have been shown to destroy tumor cells

**Tumor** – an abnormal growth of tissue

## 15. APPLICABLE STANDARDS

The Optune Lua treatment kit electronic components and the sterile transducer arrays comply with the latest editions of the following safety standards:

- EN 60601-1 Medical electrical equipment - Part 1: General requirements for safety
- EN 60601-1-2 Medical electrical equipment-Part 1-2: General requirements for safety- Collateral standard: Electromagnetic compatibility-Requirements and tests
- EN 60601-1-11- Medical electrical equipment -- Part 1-11: General requirements for basic safety and essential performance -- Collateral standard: Requirements for medical electrical equipment and medical electrical systems used in the home healthcare environment
- EN 60601-1-6 Part 1-6: General requirements for basic safety and essential performance - Collateral Standard: Usability
- EN 62366-1 – Application of usability engineering to medical devices
- EN 62304 - Medical device software. Software life-cycle processes

## 16. MESOTHELIOMA

### What is Cancer of the Linings of the Lungs?

In simple terms, lung cancer is a growth of cells that form a tumor in the lungs. Mesothelioma is a type of lung cancer that develops from the linings of the lungs. Just like any other form of cancer, these tumors can spread to other parts of the lungs and even to the rest of the body. Even before the tumor grows and spreads, it could cause problems breathing, coughing, bleeding and other problems. Symptoms of lung cancer depend on where and how big the tumor is.

About 3,000 patients in the U.S. are diagnosed with mesothelioma every year. Mesothelioma is usually caused by exposure at work to asbestos. Mesothelioma is a very serious disease. Less than 5% of patients with mesothelioma are alive after 5 years even using the best available treatments.

### Can Cancer of the Linings of the Lungs Be Treated?

There are currently four main options to treat mesothelioma:

- Surgery – Few patients can be cured by taking out all of the tumor
- Radiation – Following surgery, some patients have radiation therapy
- Cancer Drugs – most mesothelioma patients take cancer drugs. There are several approved drugs to treat mesothelioma.
- Optune Lua treatment kit together with cancer drugs

Radiation therapy and surgery can help people with mesothelioma live longer than if they had no treatment. Adding the Optune Lua treatment kit to cancer drugs may help people with mesothelioma to live longer than with cancer drugs alone. Surgery, radiation and cancer drugs have side effects. These side effects include pain, hair loss, skin irritation, nausea, vomiting, loss of appetite, effects related to breathing, and tiredness. The Optune Lua treatment kit leads to skin related problems under the transducer arrays in many people.

## 17. EMITTED RADIATION AND ELECTROMAGNETIC COMPATIBILITY

The Optune Lua device and the accompanying battery charger (ICH9100) and power supply (SPS9200) need special precautions regarding EMC and need to be installed and put into service according to the EMC information provided below.

Portable and mobile RF communications equipment can affect the Optune Lua treatment kit and the accompanying battery charger.

The Optune Lua device (TFT9200) should be used with the following cables and additional parts only:

1. connection cable (CAD9100)
2. ILE Transducer Arrays (ILE1010; ILE1030; ILE1010W; ILE1030W)
3. battery (IBH9200)
4. power supply (SPS9200)
5. Battery charger (ICH9100)
6. Unshielded AC mains cables for indoor use only with a maximal length of 1.5m

The use of accessories, parts and cables other than those specified may result in increased EMISSIONS or decreased IMMUNITY of the Optune Lua treatment kit.

**Table 1 – Guidance and MANUFACTURER’S declaration – ELECTROMAGNETIC EMISSIONS – for all ME EQUIPMENT and ME SYSTEMS**

Guidance and manufacturer’s declaration – electromagnetic emissions		
The Optune Lua treatment kit is intended for use in the electromagnetic environment specified below. The customer or the user of the Optune Lua <b>treatment kit</b> should assure that it is used in such an environment.		
Emissions test	Compliance	Electromagnetic environment – guidance
RF emissions CISPR 11	Group 1	The Optune Lua treatment kit uses RF energy only for its internal function. Therefore, its RF emissions are very low and are not likely to cause any interference in nearby electronic equipment.
RF emissions CISPR 11	Class B	The Optune Lua treatment kit is suitable for use in all establishments, including domestic establishments and those directly connected to the public low-voltage
Harmonic emissions IEC 61000-3-2	Class A	

Voltage fluctuations/ flicker emissions IEC 61000-3-3	Complies	power supply network that supplies buildings used for domestic purposes.
---	----------	--

Guidance and manufacturer's declaration – electromagnetic emissions		
The ICH9100 charger and the SPS9200 power supply are intended for use in the electromagnetic environment specified below. The customer or the user of the ICH9100 charger and the SPS9200 power supply should assure that it is used in such an environment.		
Emissions test	Compliance	Electromagnetic environment – guidance
RF emissions CISPR 11	Group 1	The ICH9100 charger and the SPS9200 power supply use RF energy only for their internal function. Therefore, their RF emissions are very low and are not likely to cause any interference in nearby electronic equipment.
RF emissions CISPR 11	Class B	The ICH9100 charger and the SPS9200 power supply are suitable for use in all establishments, including domestic establishments and those directly connected to the public low-voltage power supply network that supplies buildings used for domestic purposes.
Harmonic emissions IEC 61000-3-2	Class A	
Voltage fluctuations/ flicker emissions IEC 61000-3-3	Complies	

Warning: The Optune Lua treatment kit, the ICH9100 charger and the SPS9200 power supply should not be used adjacent to or stacked with other equipment.

**Table 2 – Guidance and MANUFACTURER’S declaration – ELECTROMAGNETIC IMMUNITY – for all ME EQUIPMENT and ME SYSTEMS**

Guidance and manufacturer’s declaration – electromagnetic immunity			
The Optune Lua (model NovoTTF-200T) treatment kit is intended for use in the electromagnetic environment specified below. The customer or the user of the Optune Lua treatment kit should assure that it is used in such an environment.			
Emissions test	IEC 60601 Test level	Compliance level	Electromagnetic environment – guidance
Electrostatic discharge (ESD) IEC 61000-4-2	±8 kV contact, ± 2 kV, ± 4 kV, ±8 Kv, ± 15 kV air	±8 kV contact, ± 2 kV, ± 4 kV, ±8 kV ± 15 kV air	Floors should be wood, concrete or ceramic tile. If floor are covered with synthetic material, the relative humidity should be at least 30%.
Electrical fast transient/burst IEC 61000-4-4	±2 kV for power supply lines ±1 kV for input/output lines	±2 kV for power supply lines ±1 kV for input/output lines 100 kHz repetition frequency	Mains power quality should be that of a typical commercial or hospital environment.
Surge IEC 61000-4-5	± 0,5 kV, ±1 kV line to line ± 0,5 kV, ± 1 kV, ±2 kV line to ground	± 0,5 kV, ±1 kV line to line ± 0,5 kV, ± 1 kV, ±2 kV line to ground	Mains power quality should be that of a typical commercial or hospital environment.
Voltage dips, short interruptions and voltage variations on power supply input lines IEC 61000-4-11	0 % UT; 0,5 cycle At 0°, 45°, 90°, 135°, 180°, 225°, 270° and 315° % UT; 1 cycle and 70 % UT; 25/30 cycles Single phase: at 0°  0 % UT; 250/300 cycle	0 % UT; 0,5 cycle At 0°, 45°, 90°, 135°, 180°, 225°, 270° and 315° 0 % UT; 1 cycle and 70 % UT; 25/30 cycles Single phase: at 0°  0 % UT; 250/300 cycle	Mains power quality should be that of a typical commercial or hospital environment.
Power frequency (50/60 Hz) magnetic field IEC 61000-4-8	30 A/m	30 A/m	Power frequency magnetic fields should be at levels characteristic of a typical location in a typical commercial or hospital environment.

NOTE UT is the a.c. mains voltage prior to application of the test level.

Guidance and manufacturer's declaration – electromagnetic immunity			
The ICH9100 charger and the SPS9200 power supply are intended for use in the electromagnetic environment specified below. The customer or the user of the ICH9100 charger and the SPS9200 power supply should assure that they are used in such an environment.			
Emissions test	IEC 60601 Test level	Compliance level	Electromagnetic environment – guidance
Electrostatic discharge (ESD) IEC 61000-4-2	± 8 kV contact ± 2 kV, ± 4 kV, ± 8 kV, ± 15 kV air	± 8 kV contact ± 2 kV, ± 4 kV, ± 8 kV, ± 15 kV air	Floors should be wood, concrete or ceramic tile. If floor are covered with synthetic material, the relative humidity should be at least 30%.
Electrical fast transient/burst IEC 61000-4-4	±2 kV for power supply lines ±1 kV for input/output lines	±2 kV for power supply lines ±1 kV for input/output lines 100 kHz repetition frequency	Mains power quality should be that of a typical commercial or hospital environment.
Surge IEC 61000-4-5	± 0,5 kV, ± 1 kV line to line  ± 0,5 kV, ± 1 kV, ± 2 kV line to ground	± 0,5 kV, ± 1 kV line to line  ± 0,5 kV, ± 1 kV, ± 2 kV line to ground	Mains power quality should be that of a typical commercial or hospital environment.
Voltage dips, short interruptions and voltage variations on power supply input lines IEC 61000-4-11	0 % UT; 0,5 cycle At 0°, 45°, 90°, 135°, 180°, 225°, 270° and 315°  % UT; 1 cycle and 70 % UT; 25/30 cycles Single phase: at 0°  0 % UT; 250/300 cycle	0 % UT; 0,5 cycle At 0°, 45°, 90°, 135°, 180°, 225°, 270° and 315° 0 % UT; 1 cycle and 70 % UT; 25/30 cycles h) Single phase: at 0°  0 % UT; 250/300 cycle	Mains power quality should be that of a typical commercial or hospital environment.
Power frequency (50/60 Hz) magnetic field IEC 61000-4-8	30 A/m	30 A/m	Power frequency magnetic fields should be at levels characteristic of a typical location in a typical commercial or hospital environment.
NOTE UT is the a.c. mains voltage prior to application of the test level = 120V and 230V			

**Table 3 – Guidance and MANUFACTURER’S declaration – ELECTROMAGNETIC IMMUNITY – for ME EQUIPMENT and ME SYSTEMS that are not LIFE-SUPPORTING**

Guidance and manufacturer’s declaration – electromagnetic immunity			
The Optune Lua treatment kit is intended for use in the electromagnetic environment specified below. The customer or the user of the Optune Lua treatment kit should assure that it is used in such an environment.			
Immunity test	IEC 60601 test level	Compliance level	Electromagnetic environment – guidance
<p>Conducted RF IEC 61000-4-6</p> <p>Radiated RF IEC 61000-4-3</p>	<p>3 V 0,15 MHz – 80 MHz 6 V in ISM bands between 0,15 MHz and 80 MHz</p> <p>80 % AM at 1 kHz (table 8.5.1)</p> <p>10 V/m</p>	<p>3 V 0,15 MHz – 80 MHz 6 V in ISM bands between 0,15 MHz and 80 MHz</p> <p>80 % AM at 1 kHz</p> <p>10 V/m 80 MHz to 2.7 GHz 80 % AM at 1 kHz</p>	<p>Portable and mobile RF communications equipment should be used no closer to any part of the Optune Lua treatment kit, including cables, than the recommended separation distance calculated from the equation applicable to the frequency of the transmitter.</p> <p>Recommended separation distance</p> $d = \frac{6}{E} \sqrt{P}$ <p>Where P is the maximum power in W, d is the minimum separation distance in m, and E is the IMMUNITY TEST LEVEL in V/m.</p> <p>Field strengths from fixed RF transmitters, as determined by an electromagnetic site survey<sup>a</sup>, should be less than the compliance level in each frequency range.</p> <p>Interference may occur in the vicinity of equipment marked with the following symbol:</p> 
<p>Radiated fields in close proximity</p> <p>Standard IEC 61000-4-39</p>	<p>8A/m 30kHz CW</p> <p>65A/m 134.2kHz pulse modulated 2.1kHz</p> <p>7.5A/m 13.56MHz pulse modulated 50kHz</p>	<p>5cm distance</p>	
<p>NOTE These guidelines may not apply in all situations. Electromagnetic propagation is affected by absorption and reflection from structures, objects and people.</p>			

- a. Field strengths from fixed transmitters, such as base stations for radio (cellular/cordless) telephones and land mobile radios, amateur radio, AM and FM radio broadcast and TV broadcast cannot be predicted theoretically with accuracy. To assess the electromagnetic environment due to fixed RF transmitters, an electromagnetic site survey should be considered. If the measured field strength in the location in which the Optune Lua treatment kit is used exceeds the applicable RF compliance level above, the Optune Lua treatment kit should be observed to verify normal operation. If abnormal performance is observed, additional measures may be necessary, such as re-orienting or relocating the Optune Lua treatment kit.

Guidance and manufacturer's declaration – electromagnetic immunity

The ICH9100 charger and the SPS9200 power supply are intended for use in the electromagnetic environment specified below. The customer or the user of the ICH9100 charger and the SPS9200 power supply should assure that they are used in such an environment.

Immunity test	IEC 60601 test level	Compliance level	Electromagnetic environment – guidance
Conducted RF IEC 61000-4-6	3 V 0,15 MHz – 80 MHz 6 V in ISM bands between 0,15 MHz and 80 MHz	3 V 0,15 MHz – 80 MHz 6 V in ISM bands between 0,15 MHz and 80 MHz	Portable and mobile RF communications equipment should be used no closer to any part of the ICH9100 charger and the SPS9200 power supply, including cables, than the recommended separation distance calculated from the equation applicable to the frequency of the transmitter.  Recommended separation distance $d = \frac{6}{E} \sqrt{P}$ Where P is the maximum power in W, d is the minimum separation distance in m, and E is the IMMUNITY TEST LEVEL in V/m.
Radiated RF IEC 61000-4-3	80 % AM at 1 kHz (table 8.5.1)  10 V/m	80 % AM at 1 kHz  10 V/m 80 MHz to 2.7 GHz 80 % AM at 1 kHz	Field strengths from fixed RF transmitters, as determined by an electromagnetic site survey <sup>a</sup> , should be less than the compliance level in each frequency range.  Interference may occur in the vicinity of equipment marked with the following symbol: 

NOTE These guidelines may not apply in all situations. Electromagnetic propagation is affected by absorption and reflection from structures, objects and people.

- a. Field strengths from fixed transmitters, such as base stations for radio (cellular/cordless) telephones and land mobile radios, amateur radio, AM and FM radio broadcast and TV broadcast cannot be predicted theoretically with accuracy. To assess the electromagnetic environment due to fixed RF transmitters, an electromagnetic site survey should be considered. If the measured field strength in the location in which the ICH9100 charger and the SPS9200 power supply are used exceeds the applicable RF compliance level above, the ICH9100 charger and the SPS9200 power supply are should be observed to verify normal operation. If abnormal performance is observed, additional measures may be necessary, such as re-orienting or relocating the ICH9100 charger and the SPS9200 power supply.

Normal operation: The Optune Lua treatment kit is working properly when the blue LED surrounding the TTFIELDS button are lit and no notification signal sounds. The ICH9100 charger is working properly when all the LEDs are lit. The SPS9200 power supply is working properly when the blue LEDs surrounding the TTFIELDS button on the Optune Lua device are lit and no notification signal sounds.

**Table 4 – Recommended separation distances between portable and mobile RF communications equipment and the ME EQUIPMENT or ME SYSTEMS – for ME EQUIPMENT and ME SYSTEMS that are not LIFE-SUPPORTING**

Rated maximum output power of transmitter W	Separation distance according to frequency of transmitter m						
	380 – 390MHz	430 – 470MHz	704 – 787MHz	800 – 960MHz	1700 – 1990MHz	2400 – 2570MHz	5100 – 5800MHz
The Optune Lua treatment kit is intended for use in an electromagnetic environment in which radiated RF disturbances are controlled. The customer or the user of the Optune Lua treatment kit can help prevent electromagnetic interference by maintaining a minimum distance between portable and mobile RF communications equipment (transmitters) and the Optune Lua treatment kit as recommended below, according to the maximum output power of the communications equipment.							
0.2	0.3	0.3	0.3	0.3	0.3	0.3	0.3
1.8	0.3	0.3	0.3	0.3	0.3	0.3	0.3
2	0.3	0.3	0.3	0.3	0.3	0.3	0.3
NOTE: These guidelines may not apply in all situations. Electromagnetic propagation is affected by absorption and reflection from structures, objects and people.							
For transmitters rated at a maximum output power not listed above, the recommended separation distance $d$ in meters (m) can be determined using the equation applicable to the frequency of the transmitter, where $P$ is the maximum output power rating of the transmitter in watts (W) according to the transmitter manufacturer.							

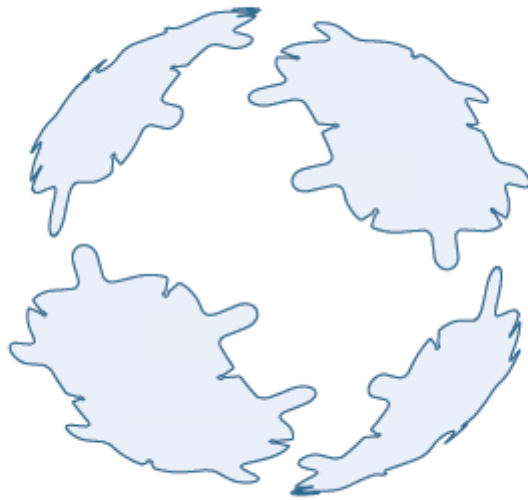

**novocure**<sup>®</sup>



Importer details:  
Novocure Netherlands B.V., Prins Hendriklaan 26,  
1075 BD, Amsterdam, The Netherlands



European authorized representative  
MDSS GmbH  
Schiffgraben 41  
30175 Hannover, Germany



Manufacturer Information:  
Novocure GmbH, Neuhofstrasse 21,  
6340 Baar, Switzerland

CE 0197

QSD-EUUM-200 EU(EN) Rev04 April 2025  
[manuals.novocure.eu](http://manuals.novocure.eu)